



Smith & Wesson®

Owner's Manual
.....
22A/22S Sport Series
Target Pistols



Read the instructions and
warnings in this manual
CAREFULLY BEFORE using
this firearm.

2100 Roosevelt Avenue • Springfield, MA 01104
1-800-331-0852 • Fax: 413-747-3317
www.smith-wesson.com

**READ THESE INSTRUCTIONS
AND WARNINGS CAREFULLY. BE
SURE YOU UNDERSTAND THESE
INSTRUCTIONS AND WARNINGS
BEFORE USING THIS FIREARM.**

**This SAFETY, INSTRUCTION
and PARTS MANUAL should
always accompany this firearm
and be transferred with it upon
change of ownership or presented
to another person. A copy of the
SAFETY, INSTRUCTION, & PARTS
MANUAL is available FREE upon
request from:**

**SMITH & WESSON
CUSTOMER SUPPORT CENTER
2100 ROOSEVELT AVENUE
SPRINGFIELD, MA 01104
TEL.: 1-800-331-0852
E-mail: qa@smith-wesson.com**

INDEX

SAFETY	4
BASIC FIREARMS SAFETY RULES	5-6
SAFE STORAGE AND TRANSPORTATION	7-8
NOMENCLATURE	8-9
PREPARATION FOR FIRING	9-10
AMMUNITION	10-12
MODEL NUMBER IDENTIFICATION	13
INSPECTING YOUR PISTOL	14
LOADING	15-16
FIRING	17
CLEARING MISFIRES	17
UNLOADING	18
FIELD STRIPPING DISASSEMBLY	19-21
FIELD STRIPPING REASSEMBLY	22
LUBRICATION	23
MAGAZINE DISASSEMBLY	23
MAGAZINE ASSEMBLY	24
CLEANING & MAINTENANCE	25
SERVICE, SHIPPING & PARTS	26-27
WARRANTY	28
EXTENDED SERVICE POLICY	29
COMPONENTS	30
WARNINGS	31

SAFETY

SAFETY IS YOUR NUMBER ONE RESPONSIBILITY!!!!



WARNING: YOU MUST FOLLOW ALL OF THESE SAFETY RULES TO ENSURE THE SAFE USE OF YOUR FIREARM

- **Safe gun handling is YOUR personal responsibility at all times.** Firearms are dangerous and can cause serious injury and death if they are misused or used inappropriately. Safety must be the prime consideration of anyone who owns or handles firearms.
- **You are responsible for the firearm at all times.** In owning a firearm, you must undertake full-time responsibility for your firearm's safety and security. You must protect yourself and all others against injury or death from misuse of the firearm.
- **Safe storage is your responsibility.** In particular, you must secure firearms safely from children and unauthorized users. A lock has been provided for your use with this firearm. A lock is not a substitute for safe and secure storage as defined in the "Safe Storage and Transportation" section of this manual.
- **Accidents are the result of violating the rules of safe gun handling and common sense.**
- **For your safety and the safety of others, never rely on mechanical features alone.** Only your safe gun-handling habits will ensure the safe use of your firearm. This is your responsibility.
- **Never keep ammunition in the same location as the handgun.** Store in a separate and secure place.
- **READ and UNDERSTAND these instructions before using your firearm.**

BASIC FIREARM SAFETY RULES

At home, in the field, at the range, or anywhere, the first concern of every firearm owner should be safety. Apply the following safety rules in every situation, with any kind of firearm.



WARNING!

THE FAILURE TO FOLLOW THESE BASIC FIREARM SAFETY RULES MAY RESULT IN AN UNINTENDED DISCHARGE WHICH COULD CAUSE SERIOUS PERSONAL INJURY OR DEATH.

- **BEFORE HANDLING ANY FIREARM, UNDERSTAND ITS OPERATION.** Not all firearms are the same. Familiarize yourself with the mechanical features of any firearm you intend to use. If you feel uncertain about any operational aspects of your handgun, please contact Smith & Wesson at 1-800-331-0852 before proceeding with its operation.
- **ALWAYS SAFELY STORE AND SECURE YOUR FIREARM.** Safe and secure storage of your firearm is one of the most important responsibilities of firearms ownership. It is a full-time responsibility. You must always secure your firearm and ammunition separately so that they are not accessible to children or other unauthorized persons. (See Safe Storage Instructions.)
- **ALWAYS TREAT EVERY FIREARM AS IF IT WERE LOADED AND WOULD FIRE IF THE TRIGGER IS PULLED.** Do not take anyone's word that the firearm is unloaded – always check for yourself. Never pass your firearm to another person until the cylinder or action is open and you visually check that it is unloaded. Keep your firearm unloaded and safely stored when not in use.
- **ALWAYS KEEP YOUR FIREARM POINTED IN A SAFE DIRECTION.** Never point a firearm at anyone or anything you do not intend to shoot whether or not it is loaded. This is particularly important when loading, unloading, or field stripping the gun. ALWAYS control the direction of the firearm.
- **NEVER PLACE YOUR FINGER INSIDE THE TRIGGER GUARD UNLESS YOU INTEND TO FIRE.** Your firearm cannot fire unless the trigger is pulled. Ensure that other objects do not actuate the trigger.
- **ALWAYS BE SURE OF YOUR TARGET AND WHAT IS BEYOND IT.** Always be sure of where the bullet will strike and shoot only where there is a safe backstop free of obstructions, water or other surfaces which can cause ricochets. Do not fire into the sky.

BASIC FIREARM SAFETY RULES CONT'D.

ADDITIONAL IMPORTANT SAFETY RULES

- Never carry or store a firearm with the hammer or striker in the cocked position.
- Do not allow a firearm to be used by individuals who have not read these basic firearms safety rules and do not understand its safe operation and the rules of safe gun-handling.
- Be sure all accessories, such as holsters and grips, are compatible with the firearm and that the accessories do not interfere with safe operation.
- Use the correct ammunition for your particular firearm as indicated by the marking on the barrel. Never use non-standard, reloaded, or "handloaded" ammunition which has not been subjected to internal ballistic pressure testing.
- Discharging firearms in poorly ventilated areas, cleaning firearms, or handling ammunition may result in exposure to lead and other substances known to cause birth defects, reproductive harm, and other serious physical injury. Review the warnings and labels for all ammunition and cleaning products carefully. Have adequate ventilation at all times. Wash hands thoroughly after exposure.
- Never use alcohol or drugs before or while shooting. Do not use your firearm if you are on any medication which impairs, even slightly, your mental or physical ability.
- Wear eye and hearing protection appropriate for firearm use every time you discharge your firearm. Make sure others in the vicinity of where you will be shooting do so as well.
- Do not allow any alteration or replacement of parts in your Smith & Wesson firearm unless performed by a qualified gunsmith using genuine Smith & Wesson parts. If you do otherwise, improper functioning of your firearm may occur and serious injury may result.
- Never cross obstacles such as fences or streams with a loaded firearm.
- Firearm safety training is available. Contact your dealer for availability.
- Appropriate use for your firearm means using your firearm for legal purposes. For example - target shooting and lawful resistance of deadly criminal force.
- These are basic firearms safety rules. There are other common sense safety rules that should be followed at all times under the circumstances then presented.
SAFE USE OF A FIREARM IS YOUR PERSONAL RESPONSIBILITY AND THE FAILURE TO FOLLOW ALL OF THESE BASIC SAFETY RULES MAY RESULT IN SEVERE PERSONAL INJURY OR DEATH.

SAFE STORAGE & TRANSPORTATION



WARNING: SAFE AND SECURE STORAGE OF YOUR FIREARM IS ONE OF THE MOST IMPORTANT RULES OF FIREARM SAFETY. YOUR FAILURE TO FOLLOW THESE RULES MAY RESULT IN SERIOUS INJURY OR DEATH.

- You must always secure your firearm and ammunition separately so that they are not accessible to children or other unauthorized persons.
- Safe and secure storage and transportation of your firearm are your responsibility. It is a full-time responsibility.
- **ALWAYS STORE YOUR FIREARM UNLOADED.** Your firearm and ammunition should be stored separately in places and in a manner inaccessible to children and unauthorized persons.
- **SMITH & WESSON HAS PROVIDED A LOCK FOR USE WITH YOUR FIREARM.** There are also a variety of other locks and safe storage containers available in the marketplace which may be appropriate for your particular needs. Consult your local gunshop, hardware store, or local police department for guidance on the variety of other safe storage devices or practices which may be appropriate for your particular needs. By purchasing this firearm you have taken on the responsibility of safely securing the firearm at all times and preventing its unauthorized use. It is your personal responsibility to select and use whatever devices or practices that will enable you to safely secure your firearm at all times.



DO NOT USE A LOCK ON A LOADED HANDGUN!

Only you can determine what devices or practices are appropriate for the safe storage of your firearm and your ammunition.

- **NEVER ASSUME THAT A "HIDING" PLACE IS A SECURE STORAGE METHOD.** Others may be aware of your storage location or come upon it by chance. It is your personal responsibility to use common sense when storing and securing your firearm and ammunition and to always make sure that it is not accessible to children or other unauthorized persons.
- **FOLLOW THE LAW!!** You must be familiar with all local, state, and federal laws regarding the safe storage and transportation of your firearm. Failure to know and follow the law may result in unauthorized access or use of your firearm by another. Obey all laws relating to the storage and transportation of firearms.
- **NEVER TRANSPORT A LOADED FIREARM.** When transporting your firearm, be sure it is unloaded and that the cylinder or action is open.

SAFE STORAGE & TRANSPORTATION CONT'D.

- Your local police department or gunshop will furnish you with available information on storing and/or transporting a firearm legally.
- **YOUR FIREARM IS YOUR RESPONSIBILITY.**
Protect your firearm from theft or misuse by untrained or unqualified individuals.

MAINTENANCE BEFORE STORAGE

When storing, do not encase your firearm in anything that will attract or hold moisture, for example, leather or heavy cloth. Also, do not store guns with a plug inserted in the barrel for this can be a contributing factor to moisture accumulation. If your firearm is to be stored for an extended period, the bore, chambers and internal working mechanism should be oiled with acid-free lubricating oil or preservative, and the external working mechanisms, frame, cylinder and barrel should be coated with an anti-rust oil. Before using your firearm again, be sure to clean it. Every time you clean your firearm, check it for signs of wear. If wear is noted, do not use the firearm. Return it to Smith & Wesson for service or have it checked by a qualified gunsmith.

MAINTENANCE BEFORE USE

Before using your firearm, it should be cleaned. (See Cleaning Instructions at page 24.) Your firearm has been treated with either a preservative or oil to protect it against corrosion. Before using it, all excess oil should be wiped from the bore, chambers (charge holes), and exposed areas using a clean swab or patch. A light coat of high quality gun oil should be applied to the outside surfaces and mechanism. Care should be taken not to oil the mechanism to the degree that dust and lint may be trapped by the oil.

NOMENCLATURE

Smith & Wesson handguns are reliable and safe to use when the basic firearm safety rules are followed. There are a number of internal safety mechanisms within the lockwork of the handgun which ensure that the firearm will not discharge unless the trigger of the handgun is pulled. That is one reason why it is important to never modify or alter your firearm. Before you use your handgun, you should be fully familiar with its operation.

Here is a list of basic firearms terminology.

AMMUNITION - CENTERFIRE - Ammunition which contains the primer in the center of the base of the case. Among the most common centerfire handgun cartridges are the .32, .38 Special, .380, 9mm, .357 Magnum®, .40 S&W®, .45 ACP and the .44 Magnum®.

AMMUNITION - RIMFIRE - Ammunition which contains the primer material in the rim. Among the most common rimfire handgun cartridges are the .22 Long, .22 Short, .22 LR, .22CB, .22BB, and .22 Magnum.

CALIBER - The diameter of a bullet, designated in hundredths or thousandths of an inch (.357) or in millimeters (9mm).

DECOCK - The process by which the hammer or striker is safely lowered.

NOMENCLATURE CONT'D.

DOUBLE ACTION - A firing action where the hammer or striker is drawn back, released, and the gun fired by a single pull of the trigger.

DOUBLE ACTION ONLY - A firearm designed so that it can only be fired in double action.

PISTOL - A handgun that contains the cartridges in a magazine.

REVOLVER - A handgun that contains the cartridges in a cylinder that revolves at the rear of the barrel.

SINGLE ACTION - A firing action where the hammer or striker is released from the cocked position by pulling the trigger.

The operation of your handgun will be explained in greater detail in the pages that follow, as well as a greater description of key component parts.

PREPARATION FOR FIRING



ALWAYS WEAR EYE AND EAR PROTECTION WHICH IS SPECIFIED FOR FIREARM USE.

- Failure to wear adequate and proper ear protection on even one occasion can potentially permanently damage your hearing. Make sure others who are nearby are wearing ear protection as well.
- Always wear safety glasses, whether indoors or out. Safety glasses protect your eyes from the firing flash and particles associated with the discharge of ammunition.
- **DO NOT SHOOT AT HARD SURFACES, WATER OR UP INTO THE SKY.** Always select a place to shoot that has a safe backstop, is free from obstructions and water surfaces which cause ricochets.
- Always be aware of other people so that persons cannot accidentally walk into the line of fire.
- Position the shooter and all others so that they are not within an area where they may be struck by particle-spitting from a revolver or by ejected cases from other types of firearms.
- Keep fingers and other parts of your body away from the muzzle and away from the gap between the revolver barrel and cylinder, and away from the pistol slide and ejection port.
- Be alert and always follow the safety instruction of the range officer.

PREPARATION FOR FIRING CONT'D.

- Be sure that all cylinders and actions of firearms are open, that chambers are clear of cartridges, magazines are removed, and that firearms are pointing in a safe direction before anyone is allowed in front of the firing position.
- Be alert at all times. Never shoot if you are tired, cold or impaired in any way.
- Treat your firearm as if it were loaded at all times.

AMMUNITION

A. GENERAL PRINCIPLES

- A firearm and ammunition are a system and must work together. Their performance is closely related. There are different types of ammunition for different types of firearms. Your firearm has been designed for ammunition of a specific type and a specific caliber. It is important to select the proper ammunition for your firearm.



- **Never use ammunition not specifically designated for use in your firearm. Failure to use the correct type or caliber of ammunition may cause the firearm to jam, fail to fire or even generate excessive pressure which can damage or even rupture your firearm, causing personal injury or property damage.**
- You are responsible for selecting ammunition that meets industry standards and is appropriate in type and caliber for this firearm.
- Locate the caliber designation printed on the handgun. This information indicates the ammunition caliber that should be used in this firearm. (See figure #1)

B. HANDLOADED OR RELOADED AMMUNITION



- **Never use non-standard, reloaded or “handloaded” ammunition which has not been subjected to internal ballistic pressure testing.** Reloaded or handloaded ammunition, may have many manufacturing and quality variables (such as the type and amount of gun powder).
- **Any ammunition that is improperly manufactured, even in the slightest degree, may fail to fire or may generate excessive internal pressures which can damage or even rupture the firearm, causing personal injury to the shooter or those in the immediate vicinity.**



FIGURE 1

AMMUNITION CONT'D.

- Use only commercially manufactured ammunition with internal ballistic pressures which are in strict accordance with the specifications of the Sporting Arms and Ammunition Manufacturers' Institute (SAAMI).
- Be certain all ammunition you use complies with the SAAMI specifications. If you are uncertain, contact your ammunition supplier for verification.

C. MISFIRES

- If your firearm fails to fire when the trigger is pulled (misfires), keep the firearm pointed in a safe direction, remove your finger from the trigger, and wait 10 seconds. Only after you have completed all of the above steps, remove the magazine or open the cylinder and remove the cartridge from the chamber and dispose of it properly. Keep your firearm pointed in a safe direction at all times.
- If you have heard an unusual sound or felt an unusual recoil on firing, stop firing, wait 10 seconds, unload the firearm, and examine the barrel bore for obstructions.
- Make sure your barrel is clear and free of obstructions. If you see an obstruction, return your firearm to Smith & Wesson or take it to a qualified gunsmith. Never fire a firearm with an obstructed barrel.

D. AMMUNITION SPECIFICS

- Use only ammunition specifically recommended by Smith & Wesson for your firearm.
- Never mix ammunition.
- Never use a cartridge not specifically designated for use in your firearm. Pressure from the wrong type of ammunition may be beyond the capability of your firearm to withstand and may damage or even rupture your firearm.
- Whenever rimless pistol cartridges are used in the cylinder of a Smith & Wesson revolver, (except M547) full or half-moon clips MUST be used to both position and extract such cartridges. Failure to use ammunition clips with rimless cartridges may result in malfunction of the revolver.

- Additional ammunition calibers can be fired from the following list of select calibers.

<u>Caliber on Barrel</u>	<u>Can also Fire</u>
.45 Colt	.45 Schofield, .45 S&W
.45 S&W	.45 Schofield
.44 Magnum	.44 Special
.357 Magnum	.38 Special, .38 Special +P
.22LR	.22L, .22 Short, .22CB, .22BB (in revolvers only)
10mm	.40 S&W (in revolvers only)

- In some cases, a round of ammunition not specified on your handgun may fit into the chamber or cylinder. Firing ammunition not specified on your handgun may cause it to rupture and cause serious injury or death.

AMMUNITION CONT'D.

E. AMMUNITION WARNINGS

- “Plus-P” (+P) ammunition generates pressures in excess of the pressures associated with standard ammunition. Such pressures may affect the wear characteristics or exceed the margin of safety built into some revolvers and could therefore be DANGEROUS.
- “Plus-P” ammunition should not be used in medium (K frame) revolvers manufactured prior to 1958. Such pre-1958 medium (K-frame) revolvers can be identified by the absence of a model number stamped inside the yoke cut of the frame. (i.e., the area of the frame exposed when the cylinder is in the open position.
- “Plus-P-Plus (+P+)” marking on the ammunition merely designates that it exceeds established industry standards, but the designation does not represent defined pressure limits and therefore such ammunition may vary significantly as to the pressures generated.
- “Plus-P-Plus (+P+)” ammunition is not recommended for use in Smith & Wesson firearms.
- In the Model 940 revolver, some brands of 9mm parabellum ammunition may cause difficulty in extracting spent cartridge cases from the cylinder. If this situation occurs, thoroughly clean the cylinder charge holes with solvent. If this condition persists, we recommend changing to another brand of 9mm parabellum ammunition.
- Smith & Wesson has found wide variations in primer sensitivity between some brands and types of .22LR ammunition. Smith & Wesson recommends that before you put your .22LR handgun into regular use, that you fire several boxes of your choice of ammunition through it to determine reliability of ignition. If “failure to fire” occurs, try different types of brands of .22LR ammunition until a reliable loading is found.

MODEL NUMBER IDENTIFICATION

MODEL NUMBER & SERIAL NUMBER



FIGURE 2

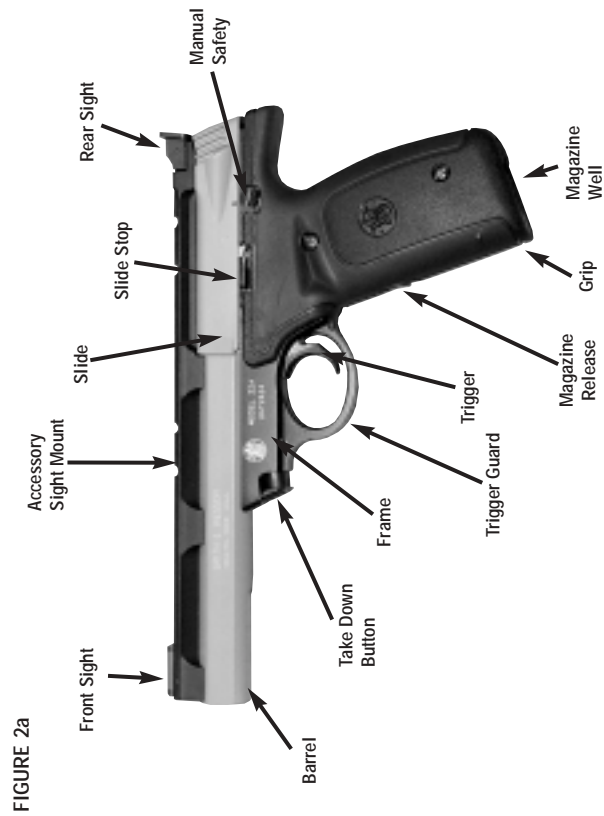
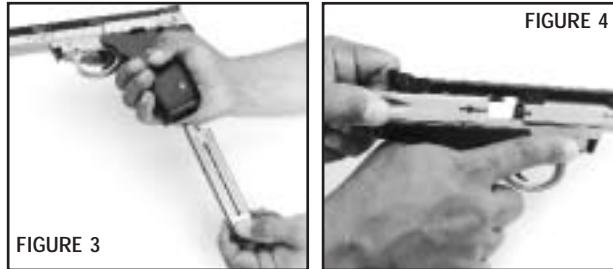

FIGURE 2a

INSPECTING YOUR PISTOL

When you inspect your pistol, you should first check for yourself to ensure that it is unloaded. To do this, grasp the pistol with your finger off the trigger and outside the trigger guard, point the pistol in a safe direction, depress the magazine release, and remove the magazine (Figure 3).



With the pistol still pointing in a safe direction, grasp the serrated sides of the slide from the rear with the thumb and fingers as shown in Figure 4, and briskly draw the slide fully rearward in order to extract any cartridge from the barrel chamber and clear it from the pistol. Do not obstruct the ejection port because doing so can interfere with ejection of a cartridge and thereby creates the risk of exploding an unchambered cartridge and possible injury. Lock the slide in the open position, by allowing the slide to move slightly forward from the rearmost position while pressing upward on the slide stop. You are now able to safety check the barrel chamber visually for any obstructions (Figure 4). You must follow this procedure every time your firearm is inspected, cleaned, handed to another person, transported or stored. Unload the magazine by holding it with the bullet end of the cartridge pointing away from you and pressing each cartridge forward and out of the magazine.

LOADING

- Do not load the pistol until you are ready to use it. Keep your finger off the trigger and outside the trigger guard until you are ready to fire.



WARNING: In 2001, a magazine safety was added to all Sport Series Pistols. Pistols with a magazine safety are designed to disengage the trigger linkage, and thereby prevent the trigger from firing the pistol when the magazine is removed from the pistol. Be certain to fully release the trigger and remove your finger from within the trigger guard when the magazine is removed from the pistol. Failure to fully release the trigger could result in firing the handgun. After inserting a magazine, always test to make sure it is locked in place by applying some removal pressure to the exposed portion of the magazine butt plate.



Smith & Wesson Sport Series pistols manufactured prior to the addition of the magazine safety will fire with the magazine removed and are marked “CAUTION - CAPABLE OF FIRING WITHOUT MAGAZINE”

If the magazine is removed with a round left in the chamber, be sure to holster or otherwise safely secure the pistol under your direct control while the magazine is being reloaded.

- Only use Smith & Wesson magazines specifically manufactured for your particular model of pistol. Do not interchange magazines from one model pistol into another model pistol.
- Smith & Wesson has provided you with a magazine designed to operate in your specific model of pistol. While your magazine may be able to be inserted into another model pistol, it will only function properly in the specific model for which it was designed.
- Follow instructions in this manual and any other specific instructions which may be marked onto, or accompany, a magazine. Failure to use the particular type of Smith & Wesson magazine specified for your model and caliber of pistol may result in a malfunction.
- Load the magazine by first pulling the follower down as you insert a cartridge rim (rear of cartridge) downward on the forward portion of the magazine follower (or downward on the case of the previously loaded cartridge) and sliding the cartridge fully under the lips of the magazine until the cartridge rim is against the rear wall of the magazine. Repeat the procedure for the number of cartridges you wish to load, up to the magazine capacity. Do not attempt to load your magazine with more than the specified number of cartridges because doing so can cause a feeding failure.
- Place the manual safety in the safe (up) position.

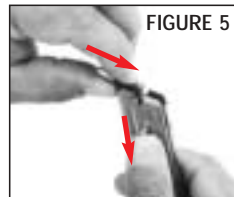

LOADING CONT'D.

- Inspect your pistol as previously described in the “Inspecting Your Pistol” section. Hold the pistol in one hand while pointing it in a safe direction and with your finger off the trigger and outside the trigger guard. Insert the loaded magazine into the magazine well (opening) with enough force to ensure that it is locked in place.



WARNING: Do not use excessive upward force when inserting a loaded magazine into the pistol. Excessive upward force could cause the slide to move forward, chambering a round and making the pistol ready to fire.

- To make sure that the magazine is fully and securely inserted, apply some removal pressure to the exposed portion of the magazine butt plate.
- Press down on the slide stop to release the slide and allow it to carry fully forward. This strips a cartridge from the magazine and seats it in the chamber of the barrel.



WARNING: The pistol will fire if the manual safety is placed in the fire (down) position and the trigger is pulled.

- Remember to keep your pistol pointed in a safe direction under all conditions and always keep your finger or any other object off the trigger and outside the trigger guard until you have made the commitment to fire the handgun. Never leave a loaded firearm unattended.

FIRING

- Keep the pistol pointed in a safe direction and your finger outside the trigger guard until you are ready to fire. Place the manual safety in the fire (down) position. While holding the grip firmly, pull the trigger fully to the rear. As the trigger is drawn fully to the rear, the hammer is released, striking the firing pin which strikes the cartridge primer. Upon firing the slide moves rearward thereby extracting and ejecting the spent cartridge case. The slide then returns forward feeding the next cartridge from the magazine into the barrel chamber.
- After firing you must allow the trigger to move forward fully before you can fire another shot. Failure to do so will prevent the lockwork from fully cycling and will prevent your being able to fire the next shot. Keep your finger off the trigger and outside the trigger guard until you are ready to fire again. This sequence can be repeated until the last round has been fired, at which time the magazine follower exerts upward pressure on the slide stop causing it to engage the slide and to hold it in the “open” position.



WARNING: Upon firing the pistol or releasing the slide from the slide stop, the slide moves rearward or forward with significant force and speed. To avoid injury be sure no part of your body interferes with the slide movement or ejection of fired case.

CLEARING MISFIRES

- If, during firing, a cartridge fails to fire, the chamber must be manually cleared. Wait ten seconds while keeping the pistol pointed in a safe direction. Verify that the manual safety is in the safe (up) position. Release and remove the magazine. Grasp the serrated sides of the slide from the rear and briskly pull the slide fully rearward to eject the misfired round. Keep your finger off of the trigger and out of the trigger guard. Do not obstruct the ejection port, and do not attempt to catch the round by placing your hand over the ejection port. (See figure 8) Also, remember that any time you release the slide while a magazine containing cartridges is in the pistol, you will have reloaded the chamber.x

UNLOADING

- Point the muzzle in a safe direction. Make sure your finger is off the trigger and out of the trigger guard. Verify that the manual safety is in the safe (up) position. Depress the magazine release, and remove the magazine (Figure 8). With the muzzle still pointing in a safe direction, and with your finger off the trigger and outside the trigger guard, grasp the sides of the slide from the rear with the thumb and fingers, and briskly draw the slide fully rearward in order to extract any cartridge from the barrel chamber and clear it from the pistol. Do not obstruct the ejection port because doing so can interfere with ejection of a cartridge and thereby creates the risk of exploding an unchambered cartridge and possible injury (Figure 9).
- Unload the magazine by holding it with the bullet end of the cartridge pointing away from you and pressing each cartridge forward and out of the magazine.



FIGURE 8



FIGURE 9

FIELD STRIPPING DISASSEMBLY

 **WARNING: SAFETY GLASSES SHOULD BE WORN DURING THIS PROCESS.**

- Point the pistol in a safe direction. Make sure your finger is off the trigger, and the trigger is in the "at rest" or forward position. Depress the magazine release, and remove the magazine. (Figure 8) With the barrel still pointing in a safe direction, and with your finger off the trigger and outside the trigger guard, grasp the serrated sides of the slide from the rear with the thumb and fingers while holding the firearm in an upright position, and briskly draw the slide fully rearward in order to extract any cartridge from the barrel chamber and clear it from the pistol. Lock the slide into the open position by pressing the slide stop lever to the up position.
- Make certain that the chamber is clear. (Figure 9)
- While holding the pistol in the shooting hand, grasp the front of the barrel with the free hand and depress the take down button. This may require significant pressure.
- While firmly holding the take down button in, lift the barrel upward until the barrel stud clears the frame (Figure 10).



 **WARNING: Do not lift barrel beyond the point necessary for barrel stud to clear the frame or damage may occur (Figure 11).**



 **WARNING: After completion of the next step, the slide, being under spring tension, could be inadvertently released from the frame and cause injury.**

FIELD STRIPPING DISASSEMBLY CONT'D.

- Release the take down button. Place the index finger of your shooting hand on the slide.
- Gently move the barrel rearward, freeing the rear sight bridge hook from the frame.
- As the barrel is lifted from the frame, capture the slide assembly with the index finger of your shooting hand.
- Lift barrel off of the frame assembly and set it aside.
(Figure 12)
- Grasp the slide with the free hand. Release the slide stop and while applying downward pressure, allow the slide to move forward until it stops (Figure 13).
- Carefully lift the rear of the slide while moving the slide forward and off of the frame (Figure 14).
- Remove the recoil spring assembly from the slide and set aside (Figure 15).



WARNING: Do not fire without the recoil spacer attached (Figure 16).



FIGURE 12



FIGURE 13



FIGURE 14

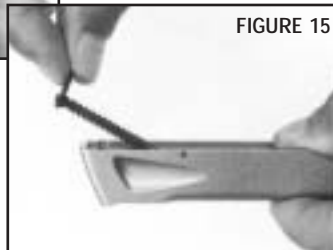
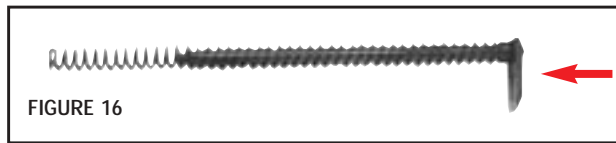

FIGURE 15

FIELD STRIPPING DISASSEMBLY CONT'D.



This completes field stripping of the firearm. No further disassembly should be attempted.

! **WARNING:** Continued dry-firing of this firearm in a disassembled state can cause damage.



FIELD STRIPPING REASSEMBLY

- While holding pistol in your shooting hand, replace the slide onto the frame (Figure 18).
- Replace the recoil spring over the recoil guide (Figure 19).
- Place the open end of the spring into the recoil housing, pressing the recoil guide rod into the slide opening. At this point, no portion of the recoil guide rod assembly should protrude above the slide (Figure 20).
- While gently pressing down, move the slide fully to the rear and engage the slide stop (Figure 21).
- Capture the slide with the index finger of your shooting hand to prevent inadvertent release from the frame, causing possible injury (Figure 22).
- Grasp the barrel in free hand by muzzle end and engage the sight bridge hook with the frame hook and pull forward (Figure 23).
- While gently lowering and pulling the barrel forward, fully depress the take down button with thumb. Ensure that the barrel stud is guided into its opening in the frame. When the barrel is fully seated, release the take down button (Figure 24).

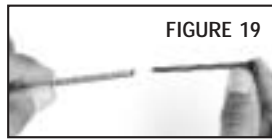

LUBRICATION

There are four (4) lubrication points where a single drop of firearms lubricant should be applied. This will assure proper lubrication of your pistol. Care should be taken not to over-lubricate. Excess lubricant can collect large quantities of unburnt powder and carbon residue, which could interfere with proper functioning of the pistol.

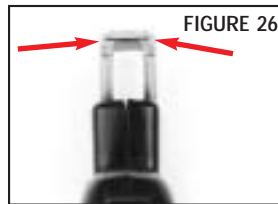

MAGAZINE DISASSEMBLY FOR CLEANING

- Remove all cartridges from magazine before disassembly
- Grasp magazine and insert drift (a common key will work as well) into the key hole and through the spring. (Figure 27).
- Using the drift, depress spring approximately one inch and slide the butt plate off of the magazine tube (Figure 28).
- Remove the spring. Slide the magazine pull-down button down to the key hole and lift to remove the button. Remove the follower (Figure 29).

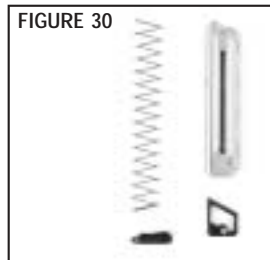
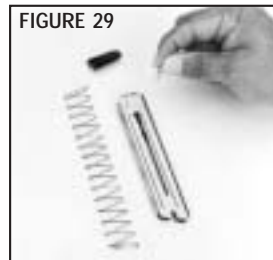

MAGAZINE REASSEMBLY

- Insert the follower into the magazine tube, lining up the bottom hole with the key hole (Figure 31).
- Insert the pull-down button into the bottom hole of the follower (Figure 32).
- Replace the spring and capture it with your index finger (Figure 33).
- Place the drift (a common key will work as well) into the key hole and through the spring and depress approximately one inch. Slide the butt plate onto the magazine tube and ensure that it is fully seated. Remove drift (Figure 34).
- Check to make sure the butt plate is secure by attempting to remove it.

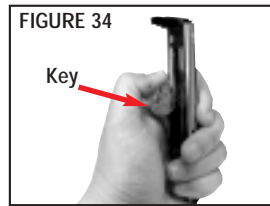

REAR SIGHT ADJUSTMENT

ADJUSTABLE SIGHT MODEL:

- The rear sight is fully adjustable for both windage and elevation. The top screw controls the elevation and each click raises or lowers the point of impact at the target. The windage adjustment screw, located on the right side of the body, controls the windage and each click moves the point of impact at the target.



CLEANING AND MAINTENANCE



**Ensure your pistol is unloaded before beginning to clean it.
At all times follow the basic rules of safe gun handling.**

Your pistol is a precision instrument and to insure reliable function, it is necessary to follow a routine maintenance procedure. After firing your pistol, be sure to unload it following the procedure outlined in the section entitled "Unloading" on page 19 before any cleaning or maintenance procedure. Your pistol should be cleaned by brushing the barrel bore and chamber with a good powder-removing solvent and bore brush. Wipe the areas clean with patches or a swab. Using a small brush dipped in solvent, remove all deposits from around the breech of the barrel, and chamber, extractor and adjacent areas which have been subjected to the action of powder or primer residue. Remove any residue on the frame with light brushing and a solvent. After cleaning the entire gun, use a cloth to apply a light film of high quality gun oil to all external surfaces and wipe clean.

CAUTION: You should avoid prolonged solvent emersion and prolonged ultrasonic cleaning of your firearm. Choice of solvent should be restricted to those products specifically developed for firearms maintenance. Instances of damage to a firearm's finish have been recorded when these cautions have been ignored. Ammoniated solvents which are chemically basic should not be used on any Smith & Wesson firearm. As a rule of thumb, if you would be comfortable applying the solvent of your choice to the finish of your automobile, it will probably be safe for use on your firearm.

After the initial cleaning, there is usually some residue in both the barrel and cylinder that works out and becomes apparent within 24-48 hours. This can be removed with a bristle brush and a light re-application of powder removing solvent after which the oil film should be re-established on all surfaces.

Cleaning is considered essential in order to ensure the proper functioning of your handgun.

For additional maintenance, we recommend the services of a qualified gunsmith. Please refer to section entitled "Service". If your firearm will be used or stored in a cold climate, be sure to use an oil that will not thicken at low temperatures.

SERVICE, SHIPPING & PARTS

For Owners Within The United States

SERVICE

Customer Service 2100 Roosevelt Avenue Springfield, MA 01104 Tel: 800-331-0852 • 413-781-8300 E-mail: qa@smith-wesson.com

Should your Smith & Wesson firearm require service, it should be returned to Smith & Wesson in its original case or in a similarly secure container. It is not necessary to take the gun to a dealer for shipment. However, before shipping your firearm, call or e-mail our Customer Service Dept. for authorization and shipping instructions.

Before shipping your handgun, ensure that the firearm is unloaded, package it securely, and do **NOT** ship any ammunition. The package must **NOT** bear any markings which indicate the identity of the contents. Enclose a letter which includes your full name and address (no P.O. Boxes, please), daytime telephone number, e-mail address, the serial number of the firearm, and details of the problem experienced or work desired. Record the serial number before shipping, in case you wish to check on the repair status of your firearm.

Ship Centerfire pistols and ALL revolvers to:

Customer Service, 2100 Roosevelt Avenue, Springfield, MA 01104

Ship ALL .22 caliber pistols to:

Customer Service, 19 Aviation Drive, Houlton, ME 04730

Please call the above telephone number or e-mail the above address before shipping!!

Since we cannot assume responsibility for custom parts and accessories, such as stocks, special sights, or holsters, please remove these items before returning your firearm.

Warranty repair work will begin upon receipt and examination of the firearm. In the case of repairs or work not covered by the warranty, a quotation covering the cost of the work plus round trip transportation charges will be sent to you. Repairs or modification will begin upon receipt of payment.

SERVICE, SHIPPING, & PARTS CONT'D.

SHIPPING

When shipping a firearm, it is most important that you comply with federal, state, and local laws and regulations. The following guidelines are meant to help, but you must seek assistance from the appropriate authorities if necessary.

- Check magazines and chambers to ensure that they are unloaded. Do not ship ammunition.
- Do not attempt to *MAIL* a handgun; only federally licensed dealers may mail a firearm.
- If your firearm must be replaced, it may be necessary to ship the replacement to a dealer rather than directly to you. You will be requested to furnish a signed FFL (Federal Firearms License) from your dealer in such an instance.
- When returning a pistol, please include all magazines ensuring they are unloaded; they are important to the proper function of the handgun.

ACCESSORIES & PARTS

Replacement parts and accessories for your Smith & Wesson firearm are available from your local Smith & Wesson Stocking Dealer, or directly from the Smith & Wesson Parts Department.

When ordering parts directly from the factory, please provide the following information:

- Model Number
- Dash Number
- Serial Number
- Approximate date of purchase
- Part view Number (refer to diagram)
- Complete Return Address
- VISA/Discover/MasterCard Number and Expiration Date
- For Foreign Orders Only, Fax Number or E-mail Address

WARRANTY

For Owners Within The United States

This warranty is granted by Smith & Wesson, 2100 Roosevelt Avenue, P.O. Box 2208, Springfield, MA 01102-2208.

This warranty is effective from the date of purchase after February 1, 1989 and applies to the original owner of any handgun purchased after that date. With respect to such handguns, this warranty supersedes any and all other warranties.

Smith & Wesson handguns are warranted to be free from defects in material and workmanship. Any such defects of which Smith & Wesson receives written notice within one year from the date of purchase by the original owner, will be remedied by Smith & Wesson without charge within a reasonable time after such notification and delivery of the handgun as provided below. If any unsafe and/or illegal condition is found during warranty inspection, Smith & Wesson will return the handgun to its original specification.

Warranty claims (in writing) and the handgun concerned should be delivered to Smith & Wesson's Customer Service Department at the above address. In addition, a copy of the bill of sale in the owner's name, or a copy of ATF Form 4473 indicating date of purchase must be included.

Warranty claims should state the model and serial number of the handgun concerned and the description of the difficulty experienced. It is recommended that shipments be insured by the owner, since Smith & Wesson will accept no responsibility for loss or damage in transit. Transportation and insurance charges for return to owner will be paid by Smith & Wesson if the claim is covered by the warranty.

UNDER NO CIRCUMSTANCES SHALL SMITH & WESSON BE RESPONSIBLE FOR INCIDENTAL OR CONSEQUENTIAL DAMAGES WITH RESPECT TO ECONOMIC LOSS, INJURY OR PROPERTY DAMAGE, WHETHER AS A RESULT OF BREACH OF EXPRESS OR IMPLIED WARRANTY, NEGLIGENCE OR OTHERWISE.

Some states do not allow the exclusion or limitation of incidental or consequential damages, so the above limitation or exclusion may not apply to you in whole or in part.

Smith & Wesson will not be responsible for defects resulting from careless handling, unauthorized adjustments or modifications, defective or improper ammunition, corrosion, neglect, abuse, ordinary wear and tear, or unreasonable use.

Smith & Wesson reserves the right to determine what constitutes ordinary wear and tear. However, we can rebuild handguns that have experienced extreme usage or are beyond their normal useful life at a fee that will be quoted to the owner.

This warranty gives you specific legal rights. You may also have other rights that vary from state to state.

EXTENDED SERVICE POLICY

For Owners Within The United States

Even after the warranty period has expired, Smith & Wesson will repair, without charge, any handgun purchased by the original owner on or after February 1, 1989 that is found to have defect in material or workmanship. Eligibility for this extended service policy requires returning the Product Registration Card within thirty days of purchase. A copy of the bill of sale in the owner's name and the sales receipt should accompany the handgun.

If any unsafe and/or illegal condition is found during warranty inspection, Smith & Wesson will return the handgun to its original specification.

This policy covers functional defects; it does not include the handgun's finish, grips, magazines or sights.

This policy is in addition to and not an extension of the Smith & Wesson Warranty.

Lifetime Service Policy

Fast Reliable Service

If you have any questions or concerns regarding your Smith & Wesson product, please give us a call. Our customer service representatives are product knowledgeable and are here to help you.

911 Priority Repair Service

In the event of an emergency (repairs needed by law enforcement, an upcoming match or hunting trip), call 1-800-331-0852 and ask for 911 Priority Repair Service. This allows you to speak with a Smith & Wesson representative. Immediately upon receipt, your handgun will be assigned to a gunsmith. After the work is completed, we will return your Smith & Wesson handgun via overnight delivery.

COMPONENT PARTS

View	Description		Description
1	Barrel Assembly	25	Manual Safety
2	Grips	26	Rear Sight Housing
3	Ejector	27	Rear Sight Blade
4	Extractor	28	Rear Sight Elevation Screw
5	Extractor Plunger	29	Rear Sight Elevation Spring
6	Extractor Spring	30	Rear Sight Windage Screw
7	Firing Pin	31	Rear Sight Windage Spring
8	Firing Pin Return Spring	32	Recoil Rod
9	Firing Pin Stop Pin	33	Recoil Spacer
10	Frame	34	Recoil Spring
11	Grip Screw	35	Sear
12	Hammer	36	Sear Spring
13	Hammer Pin	37	Slide
14	Magazine Tube	38	Slide Insert
15	Magazine Butt Plate	39	Spring Plate Assembly
16	Magazine Catch	40	Take Down Button
17	Magazine Catch Pin	41	Take Down Button Pin
18	Magazine Catch Spring	42	Take Down Button Spring
19	Magazine Follower	43	Hammer Stop Pin
20	Magazine Follower Button	44	Trigger
21	Magazine Spring	45	Trigger/Sear Pin
22	Mainspring	46	Trigger Bar Assembly
23	Mainspring Guide	47	Trigger Return Spring
24	Mainspring Guide Pin	48	Magazine Safety Assembly

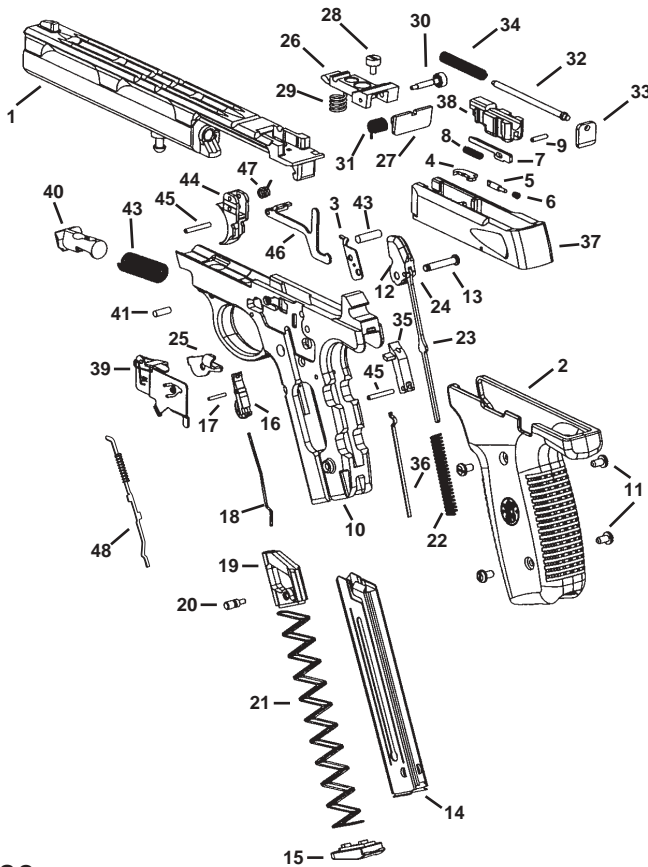

This handgun is not equipped with a device that fully blocks use by unauthorized users. More than 200,000 firearms like this one are stolen from their owners every year in the United States. In addition, there are more than a thousand suicides each year by younger children and teenagers who get access to firearms. Hundreds more die from accidental discharge. It is likely that many more children sustain serious wounds or inflict such wounds accidentally on others. In order to limit the chance of such misuse, it is imperative that you keep this weapon locked in a secure place and take other steps necessary to limit the possibility of theft or accident. Failure to take reasonable preventative steps may result in innocent lives being lost, and in some circumstances may result in your liability for these deaths.

The certification below is required only for handguns sold in the United States with a barrel length shorter than 3".
Smith & Wesson Corp. hereby certifies average accuracy test results for all new handguns with a barrel shorter than 3" as follows:

7 yards	14 yards	21 yards
1.7"	3.9"	6.3"

This certification is based on tests conducted by Smith & Wesson Corp. using a fixed handgun, rest and firing ammunition manufactured by a member of the Shooting Arms and Ammunition Manufacturers Institute (SAAMI) as defined in ANSI/SAAMI Z299.3-1993.

This certification represents actual tests based on several handguns, selected at random. Your particular handgun may have accuracy better than the results stated in this certification.

Smith & Wesson
2100 Roosevelt Avenue • Springfield, MA 01104
www.smith-wesson.com

REV:SPORT041101